



panoramic[®]
h-line

““

Each panel has a function, with infinite possibilities for personalization

””

panoramic[®]
h-line

3 Pre-assembled modules

Modular exhibits



4 Concept

Modular exhibits



- Panoramic h-line is a trade show display system which allows you to easily create a custom exhibit using pre-assembled modules.
- With its full surface area completely dedicated to the graphic image, Panoramic h-line creates an unparalleled visual impact while also providing a full assortment of useful functionalities.
- Panoramic h-line is a perfect solution for those that would like an exhibit that is both modular and flexible for purchase or rental.

5 Benefits

Five reasons to choose panoramic h-line

- **Showcase your image**
Put the graphic image front and center! No visible aluminum profile means your message is even more effective and your exhibit carries a **true mark of quality**.
- **Endless modularity**
All module types can be connected to one another - no restrictions! **Rest assured that you can use your exhibit in every space**, even those you have yet to consider. Panoramic h-line is a completely scalable solution that grows along with your company.
- **Focus on the essentials!**
Each module has been designed to provide its own unique functionality (communicate, display, design, spread your message, store, and welcome customers). **You can pre-fit certain modules by adding optional kits for even more functionality.**
- **Be creative!**
Distinguish your company by creating your own custom graphic or use our database of colors and patterns specifically chosen for Panoramic h-line. **Put a part of yourself in your exhibit!**
- **CLEVER & SIMPLE**
Panoramic h-line requires **zero technical expertise** and is set-up without the use of tools. Set-up up the exhibit yourself, or with our assistance. Standard modules do not exceed a weight of 19 lbs. Set-up for a 20' x 10' exhibit takes less than 1 hour for 1 person.

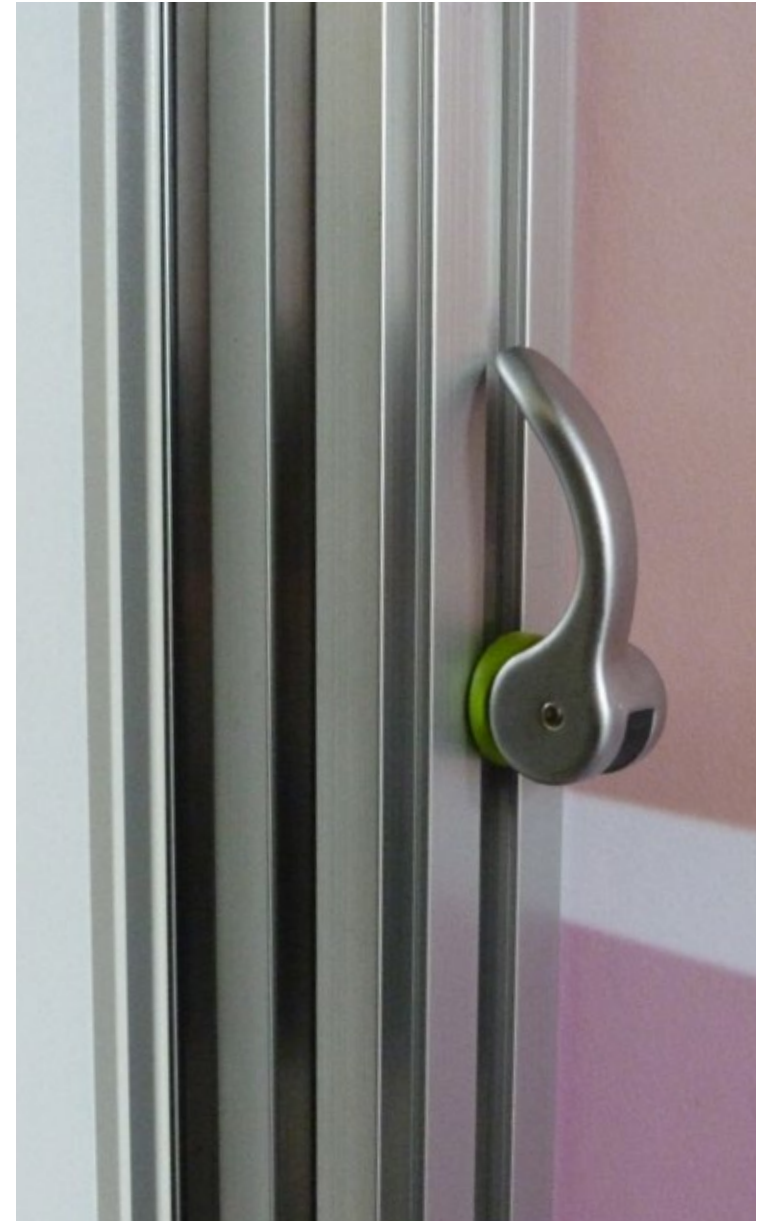

6 Concept

Formats

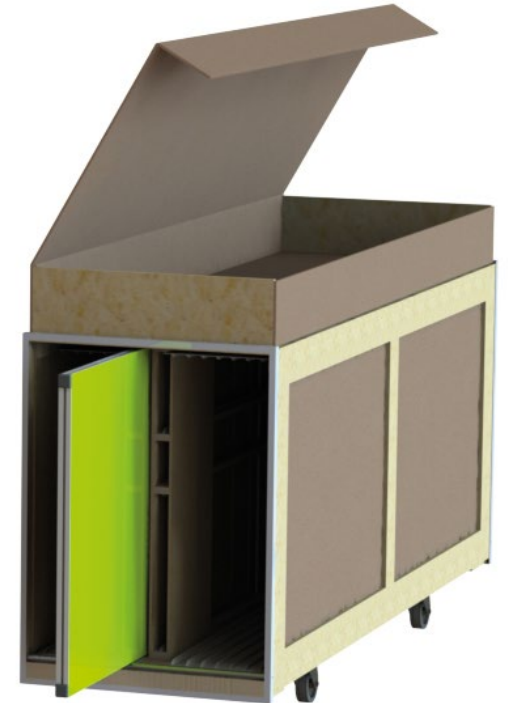
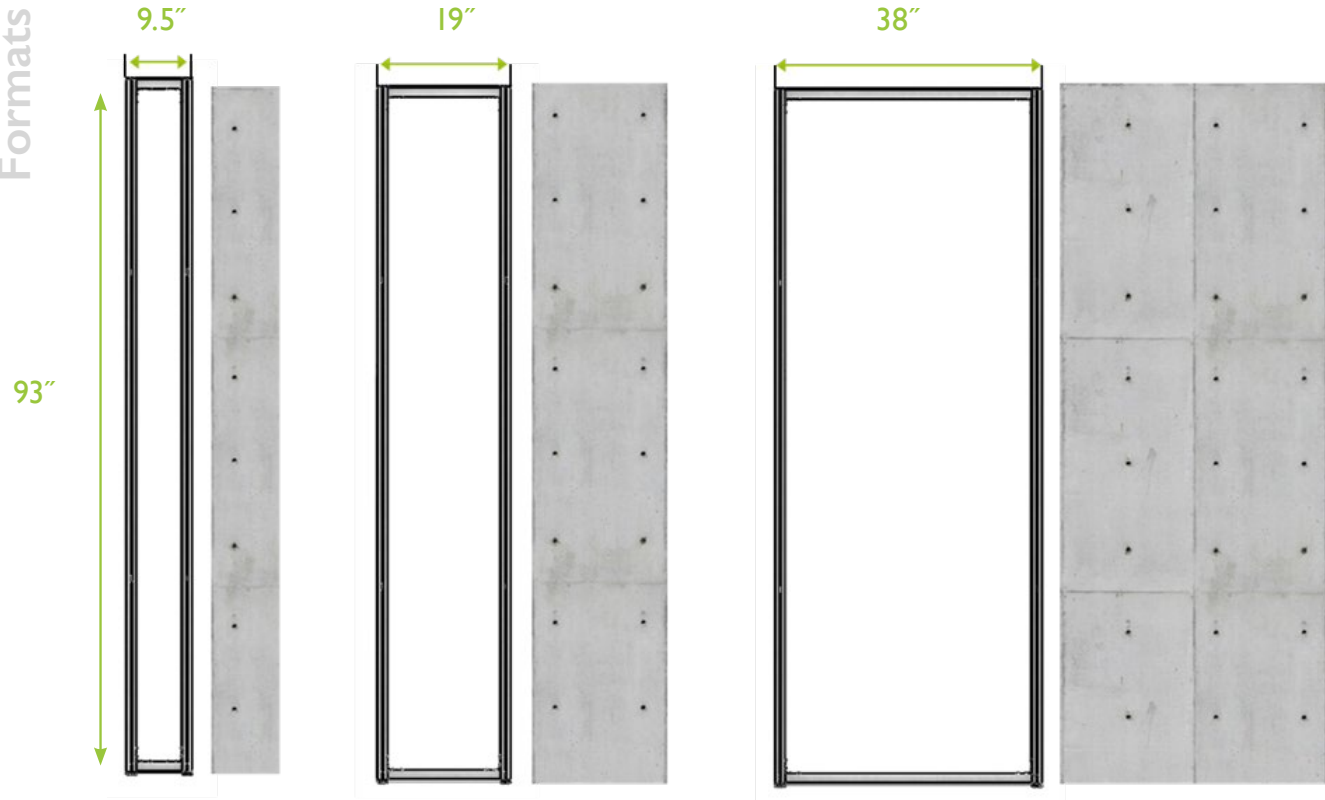

3 modules sizes:
9.5", 19" and 38"

Every panel is delivered with pre-installed graphics, just connect them!

7

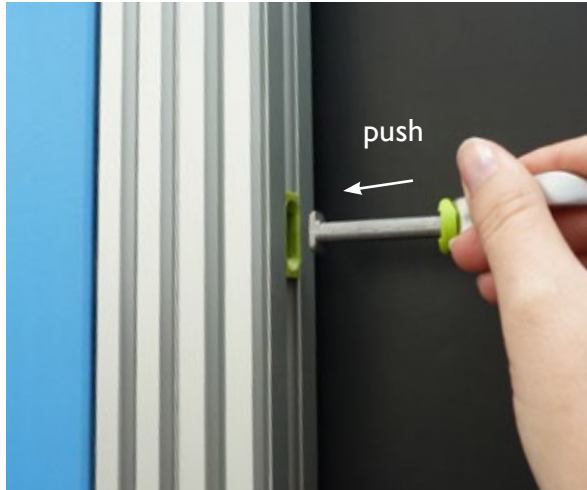

All module types can be connected to one another



Result: no visible aluminum profile!

8 Graphics

- Dye-sublimated fabric graphics
- Features a silicone edge (SEG) attachment system, in which silicone is sewn into the edge of the graphic and is then inserted into the groove of the Panoramic profile.
- Extremely precise graphic dimensions ensure perfect graphic tension upon installation
- The right fabric for each use: opaque Panopac fabric for maximum visual impact and optimal color rendering, light-diffusing fabric for lightboxes and backlit frames
- Easy to transport and ship



Grommets provide optimal and durable cable management

9 Process

Design and quote your exhibit in 4 easy steps and 30 minutes or less!

3D Studio

Welcome to the panoramic[®]
h-line

Creating an exhibit has never been so simple

STEP 01  **EXHIBIT SIZE**
To start, choose the size and type of booth that you have rented: length, width, and number of open sides.

MODULE CHOICE
At a show, every sq ft counts!
Welcome, display, store, spread your message...
Choose and position modules according to the functionalities you need.

STEP 02 

STEP 03  **GRAPHIC WRAPPING**
The most important thing at a show is to create a strong impact.
Upload your own creations or be inspired by our selection of colors, patterns, and material effects. Creativity has no limits!

FURNITURE/FINISHING
The success of your exhibit is in the details!
To finish of the look, we offer a line of furniture, lighting options and additional finishing touches.

STEP 04 

 **RENDERING**

 **ESTIMATE**

STEP 01  **BOOTH SIZE**

I DEFINE MY SPACE



I input the characteristics of my space: length, width, number of open sides.

[WWW](#) [Let's go!](#)

MODULE CHOICE  **STEP 02**

I STRUCTURE MY SPACE



I build my booth by choosing the modules that meet my needs (close an angle, more stores, spread my message, to save display products, welcome clients). All modules connect to one another.

Place info available on the website.

[WWW](#) [Let's go!](#)

STEP 03  **GRAPHIC WRAPPING**

I SELECT MY GRAPHICS



I wrap my stand: I choose between my own personalized graphics and a database of colors, patterns, or material effects. Right click and then click on the preselected graphic to wrap each booth element.

Place info available on the website.

[WWW](#) [Let's go!](#)

FINISHINGS / FURNITURE  **STEP 04**

I FINALIZE MY BOOTH



My booth is almost complete. We recommend adding finishing touches on each end of the booth and every two meters. To add more functionalities to your booth: additional chairs and lights are available to order. A database of accessories, furniture and plans for rendering purposes only, not for sale is available to you.

Place info available on the website.

[WWW](#) [Let's go!](#) [Let's go!](#) [Let's go!](#)

10 Standard modules

Communicate



MODULES

HMS001
Angled pole

HMS009
Standard module 9.5"
+ dye-sub graphic

HMS019
Standard module 19"
+ dye-sub graphic

HMS038
Standard module 38"
+ dye-sub graphic

GRAPHICS

Dye-sub graphic
to wrap an
exterior angle

Dimensions
3.15" x 93"

Dye-sub graphic

Dimensions
9.5" x 93"

Dye-sub graphic

Dimensions
19" x 93"

Dye-sub graphic

Dimensions
38" x 93"

Standard modules

Communicate

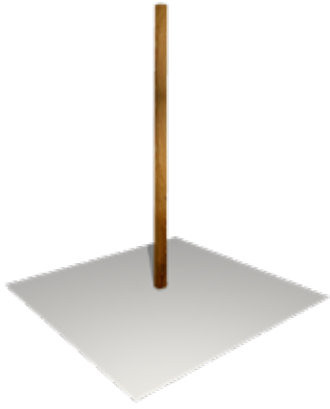

MODULES

HMSI01
Half-height angled pole
+ dye-sub graphic

HMSI09
Half-height standard module 9.5"
+ dye-sub graphic

HMSI19
Half-height standard module 19"
+ dye-sub graphic

HMSI38
Half-height standard module 38"
+ dye-sub graphic

GRAPHICS

Dye-sub graphic

Dimensions
3.15" x 46.5"

Dye-sub graphic

Dimensions
9.5" x 46.5"

Dye-sub graphic

Dimensions
19" x 46.5"

Dye-sub graphic

Dimensions
38" x 46.5"

12 Storage modules

Store

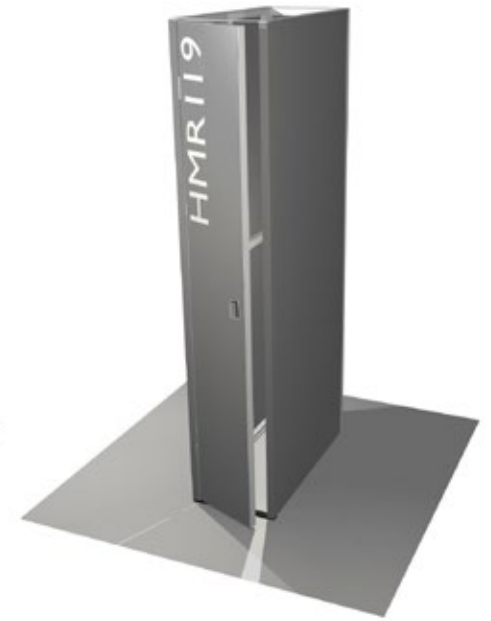

MODULES

HMR038
Storage module 38"x38"
+ dye-sub graphics

HMR138
Storage module 38"x76"
+ dye-sub graphics

HMR019
Closet module 19"x19"
+ kit of 2 shelves + dye-sub graphics

HMR119
Closet module 19"x38"
+ dye-sub graphics

GRAPHICS

6 dye-sub graphics

8 dye-sub graphics

6 dye-sub graphics

6 dye-sub graphics

Accessorize : add optional accessory kits to furnish your storage modules

13 Door modules

Store



More ergonomic and stylish door handle



MODULES

HMP019
Door module 19"
+ dye-sub graphics

HMP038
Door module 38"
+ dye-sub graphics

GRAPHICS

3 dye-sub graphics

3 dye-sub graphics

14 Standard lightbox module

Communicate

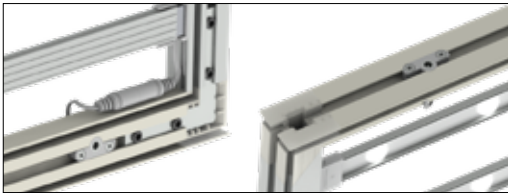

- New 1.57" thick, identical to non-backlit panels
- Perfect uniformity, without any light leakage
- Attaches to all panoramic h-line panels with one connector
- 2 outlets on each module: no more worrying about configurations!
- Shipped in h-line crate in a single slot with the graphic attached

15 Standard lightbox module - 1.57" thick

Communicate



Also available double-sided but with only one backlit side.

MODULES

HMS019-L2
Standard Lightbox module 19"
+ dye-sub graphic

HMS038-L2
Standard Lightbox module 38"
+ dye-sub graphic

GRAPHICS

Dye-sub graphic

Dimensions
19" x 93"

Dye-sub graphic

Dimensions
38" x 93"

16 Shelving modules

Display

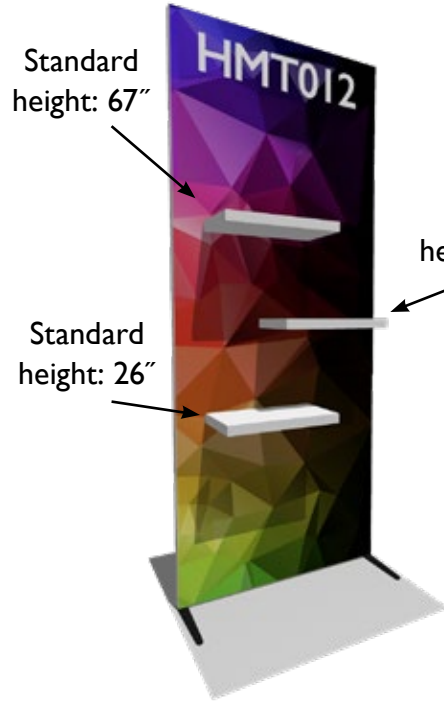

MODULES

HMT011
3-shelf module M
+ dye-sub graphic + 2 feet

HMT012
3-shelf module M
+ dye-sub graphic + 2 feet

HMT013
3-shelf module M
+ dye-sub graphic + 2 feet

HMT014
3-shelf module M
+ dye-sub graphic + 2 feet

GRAPHICS

Dye-sub graphic

Dimensions
38" x 93"

Dye-sub graphic

Dimensions
38" x 93"

Dye-sub graphic

Dimensions
38" x 93"

Dye-sub graphic

Dimensions
38" x 93"

17 Shelving modules

Display

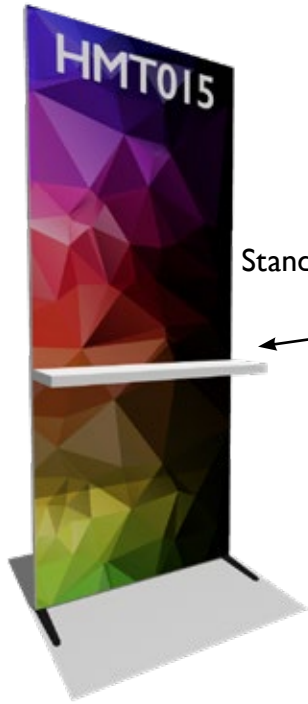

Standard height:
39.2"

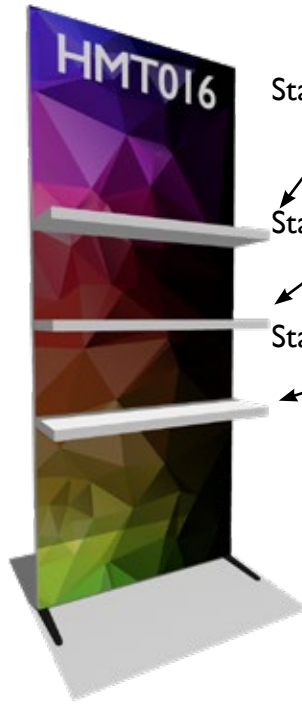

Standard height:

67"

Standard height:

46.5"

Standard height:

26"



MODULES

HMT015
1-shelf module L
+ dye-sub graphic + 2 feet

HMT016
3-shelf module L
+ dye-sub graphic + 2 feet

HMT017
1-shelf module 520 + 3 brochure holders
+ dye-sub graphic + 2 feet

GRAPHICS

Dye-sub graphic

Dimensions
38" x 93"

Dye-sub graphic

Dimensions
38" x 93"

Dye-sub graphic

Dimensions
38" x 93"

WHITE SHELVES:

Max load: 22 lbs

Dimensions:

L 18.9" x 10.25"

L 37.8" x 10.25"

L 20.4" x 10.25"

Thickness: 1.5"

Standard height of shelves from floor:

26" - 39.2" - 46.5" - 53.8" - 67"

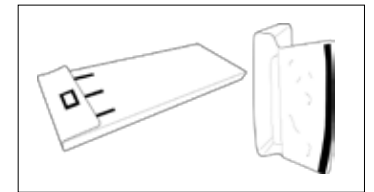

New protective shelf covers included

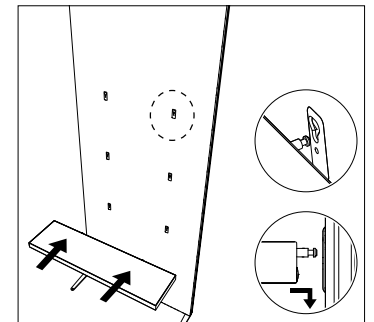

Attaches easily thanks to the universal attachment piece

18 Multimedia modules

Spread your message

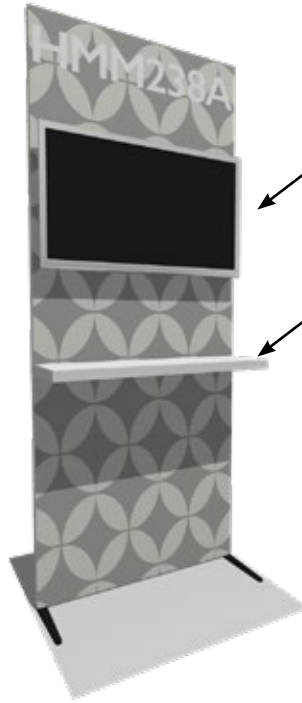

40" TV

Height:
39.2"



Brochure holder



MODULES

HMM138A
TV* Monitor Module 38"
+ dye-sub graphic + 2 feet

HMM238A
TV* Monitor Module 38"
+ dye-sub graphic + 1 L shelf + 2 feet

HMM638
TV* Monitor Module + 3 brochure holders
+ dye-sub graphic + 1 L shelf + 2 feet

GRAPHICS

Dye-sub graphic

Dye-sub graphic

Dye-sub graphic

Dimensions
38" x 93"

Dimensions
38" x 93"

Dimensions
38" x 93"

19 Accessory modules

Create your own accessory module



HCS038
38" Standard
frame



HMF002
Vertical
accessory bar



CON032
Universal accessory
attachment piece



ACS010-01
Universal
attachment hook

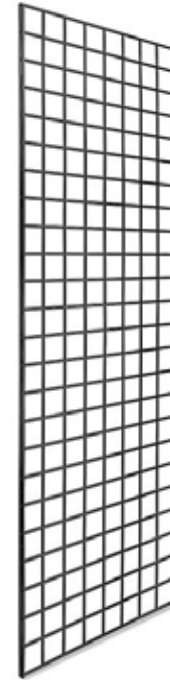

ACS018-01 white
ACS019-01 black
Gridwall and connectors



COF086
Gridwall support
connector

MODULES

GRAPHICS

Dye-sub graphic

Dimensions

38" x 93"

For each module, you will need 1 frame + the necessary amount of vertical accessory bars + 2 feet

Number of bars Recommended for	1 Brochure holder	2 TV	3 Shelves	2 Wallframe	2 Gridwall
-----------------------------------	----------------------	---------	--------------	----------------	---------------

20 Accessory modules



MODULES

HMG003
White accessory gridwall 38" module
+ dye-sub graphic + 2 feet

GRAPHICS

Dye-sub graphic

Dimensions
38" x 93"

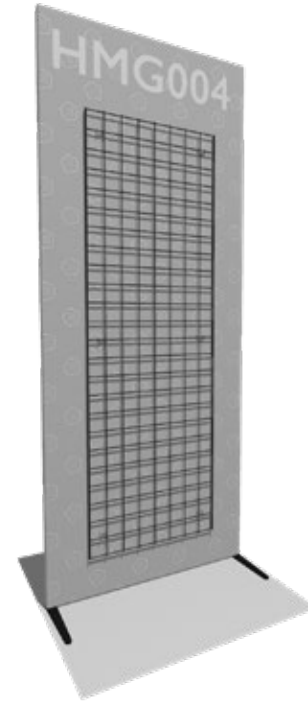

HMG004
Black accessory gridwall 38" module
+ dye-sub graphic + 2 feet

Dye-sub graphic

Dimensions
38" x 93"

Gridwall size
2'x6'
Maximum weight
33 lbs

21 Accessory modules

Create your own accessory module



ACD017 black
ACD026 white
2" straight faceout accessory bar



ACD018 black
ACD027 white
4", 7 ball waterfall accessory bar



ACD019 black
ACD028 white
6", 5 hooks waterfall accessory bar



ACD020 black
ACD029 white
2" hook accessory



ACD021 black
ACD030 white
4" hook accessory



ACD022 black
ACD031 white
6" hook accessory



ACD023 black
ACD032 white
8" hook accessory



ACD024 black
ACD033 white
10" hook accessory



ACD025 black
ACD034 white
12" hook accessory

GRIDWALL
ACCESSORIES

22 Accessory modules



MODULES

HMFO38-01
3 brochure holders module
+ dye-sub graphic + 2 feet

HMFO38-02
2 brochure holders module
+ dye-sub graphic + 2 feet

HMF138
Wallframe contour 34" x 19" module
+ dye-sub graphic + 2 feet

GRAPHICS

Dye-sub graphic

Dimensions
38" x 93"

Dye-sub graphic

Dimensions
38" x 93"

Dye-sub graphic

Dimensions
38" x 93"

23 Canopy modules

Create your own arch module

Choose the front of the arch from among the modules in the brochure (excluding doors), then select the top from among the canopy modules located below.

Design



3
flushmount
12W LED
lights

Lumineux

MODULES

HMV219A
Canopy module 19"x85"
+ dye-sub graphic

HMV238A
Canopy module 38"x85"
+ dye-sub graphic

HMV438
Canopy module with 3 LED lights
38"x85" + dye-sub graphic

HMV219-L2
Canopy module 19"x85"
+ dye-sub graphic

HMV238-L2
Canopy lightbox module 38"x85"
+ dye-sub graphic

GRAPHICS

Dye-sub graphic

Dye-sub graphic

Dye-sub graphic

Dye-sub graphic

Dye-sub graphic

Dimensions
19" x 85"

Dimensions
38" x 85"

Dimensions
38" x 85"

Dimensions
19" x 85"

Dimensions
38" x 85"

LLD022-01

3 LED spotlight kit for 38"x85.5"
canopy*

*3 spotlights + 3 panels, 60W electricity supply (LLA061) not included.

24 Arch modules

Design

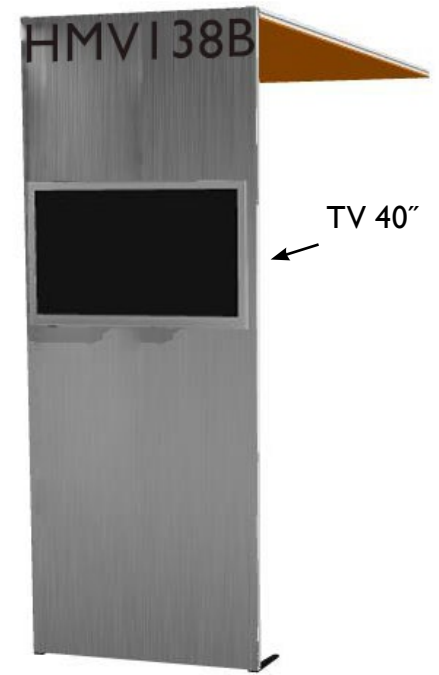
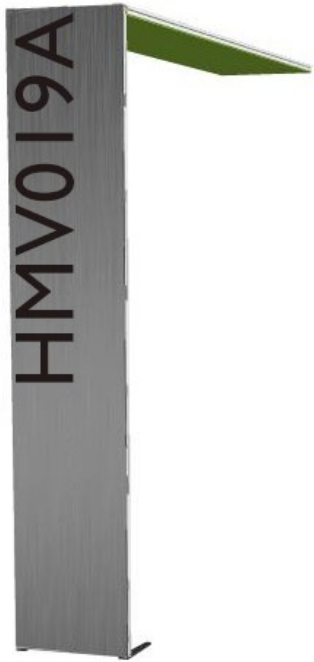

MODULES

HMV019A
Arch module 19"
+ dye-sub graphics + 2 feet

HMV038A
Arch module 38"
+ dye-sub graphics + 2 feet

HMVI38B
Arch module 38" + 40" TV*
+ dye-sub graphics + 2 feet

GRAPHICS

3 dye-sub graphics

3 dye-sub graphics

3 dye-sub graphics

*VESA monitor mount (200 x 200 / 400 x 400) with anti-theft security included in price. Recommended TV screen size: 40".
Weight: 33 lb max. Depth: 3.9" max. Optional TV.

25 Lightbox Arch modules

Design



MODULES

HMV038-L2
Arch module with front* and canopy lightboxes
+ dye-sub graphics + 2 feet

HMV438-L2
Arch module with canopy lightbox
+ dye-sub graphics + 2 feet

HMV538-L2
Arch module with front lightbox*
+ dye-sub graphics + 2 feet

GRAPHICS

3 dye-sub graphics

3 dye-sub graphics

3 dye-sub graphics

* Module can be rotated so that the rear side is backlit

Power supply bracket not included.

26 Header modules

Be seen



Raised
by
4.75"

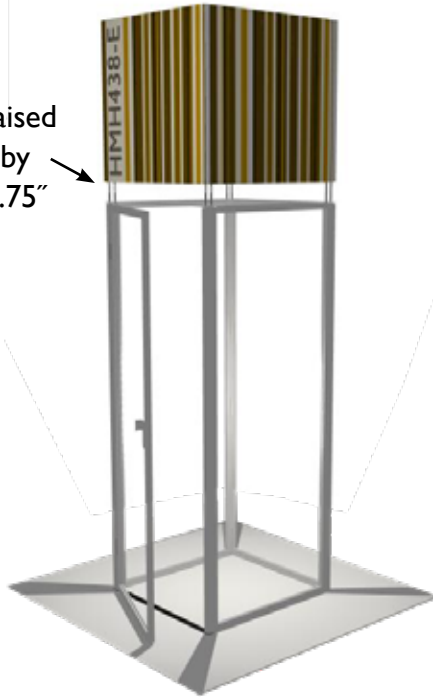

Raised
by
4.75"



MODULES

HMH438
Header module* 38"x38"
+ dye-sub graphics

HMH438-E
Header module* 38"x38" with spacers
+ dye-sub graphics

HMH638
Header module* 38"x76"
+ dye-sub graphics

HMH638-E
Header module* 38"x76" with spacers
+ dye-sub graphics

GRAPHICS

4 dye-sub graphics

4 dye-sub graphics

6 dye-sub graphics

6 dye-sub graphics

Total height
131"

Total height
136"

Total height
131"

Total height
136"

Storage modules are required for these options

*Only for 38" x 38" and 38" x 76" storage modules

27 Signage modules

Be seen

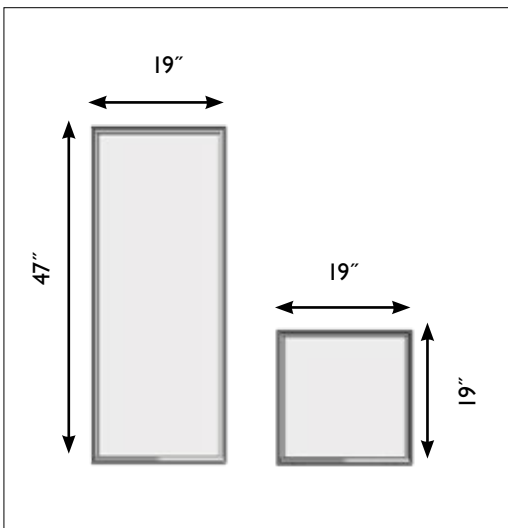
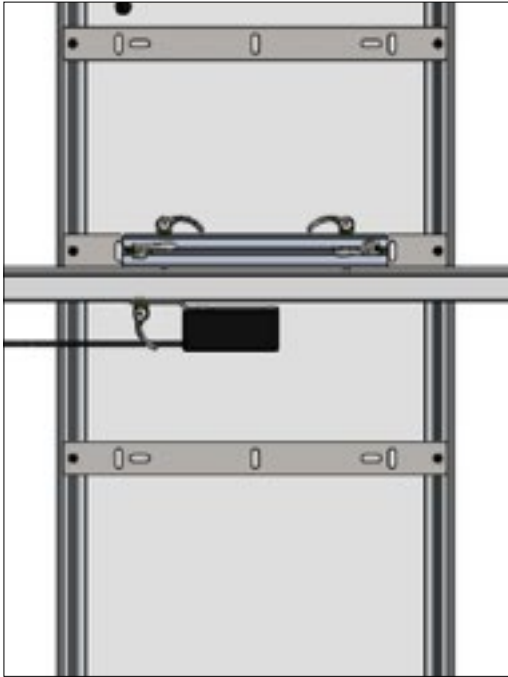

- Think outside the frame!
- 2 dimensions: 19" x 19" or 19" x 47"
- 3 pre-defined positions: low, middle, high
- Lightbox or non-lightbox
- Ships pre-assembled in the top case

28 Signage modules

Be seen

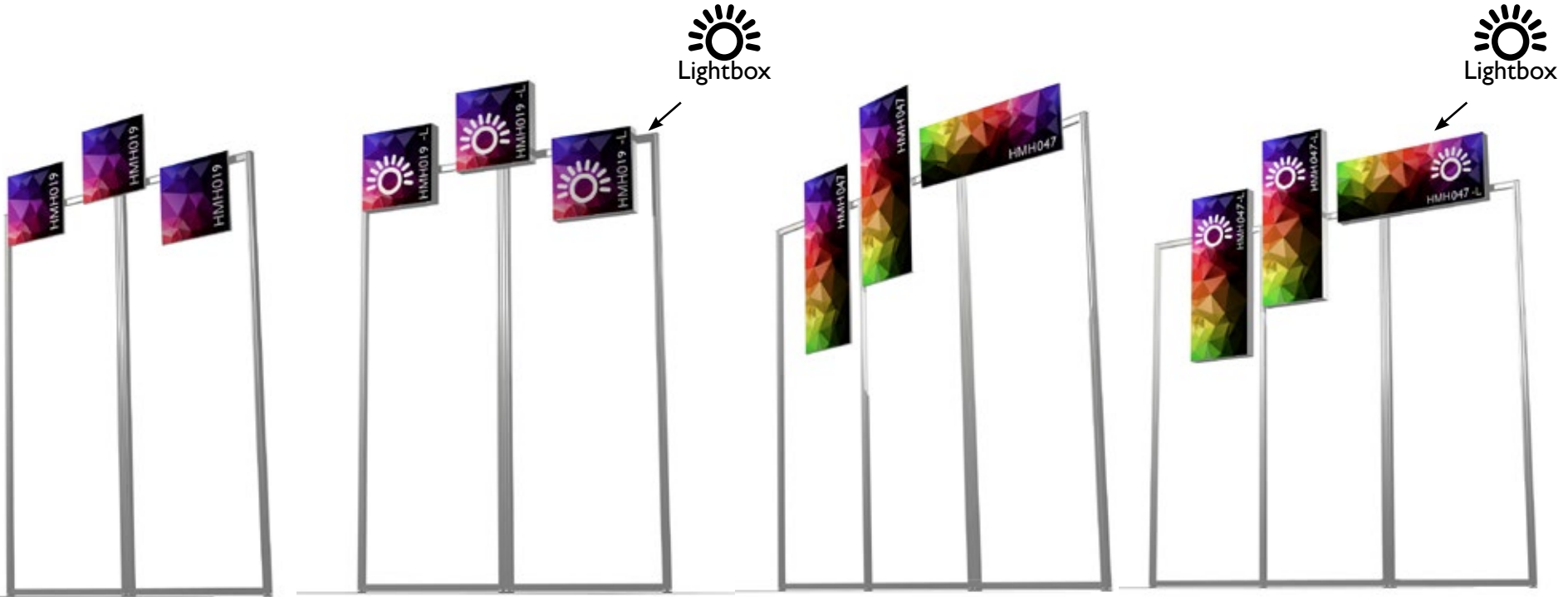

MODULES

HMH019
Signage module S
+ dye-sub graphic

HMH019-L
Lightbox signage module S
+ dye-sub graphic

HMH047
Signage module M
+ dye-sub graphic

HMH047-L
Lightbox signage module M
+ dye-sub graphic

GRAPHICS

Dye-sub graphic

Graphic dimensions
19"x19"

Dye-sub graphic

Graphic dimensions
19"x19"

Dye-sub graphic

Graphic dimensions
19"x47"

Dye-sub graphic

Graphic dimensions
19"x47"

29 USB counters and consoles

Greet

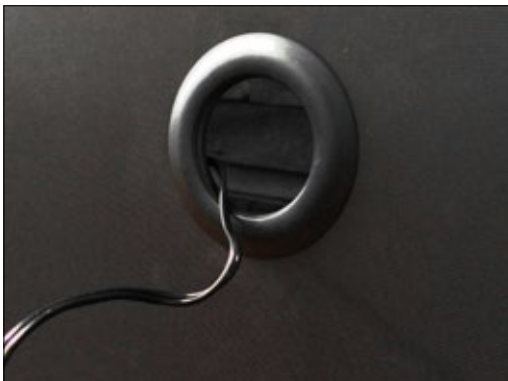

- New USB hub option
- Integrates directly into the countertop
- Equipped with 4 USB ports and a hole to feed through other cables
- Available as an add-on on counter and console modules

30 Counter modules

Greet

Total height (countertop included) : 39.5"

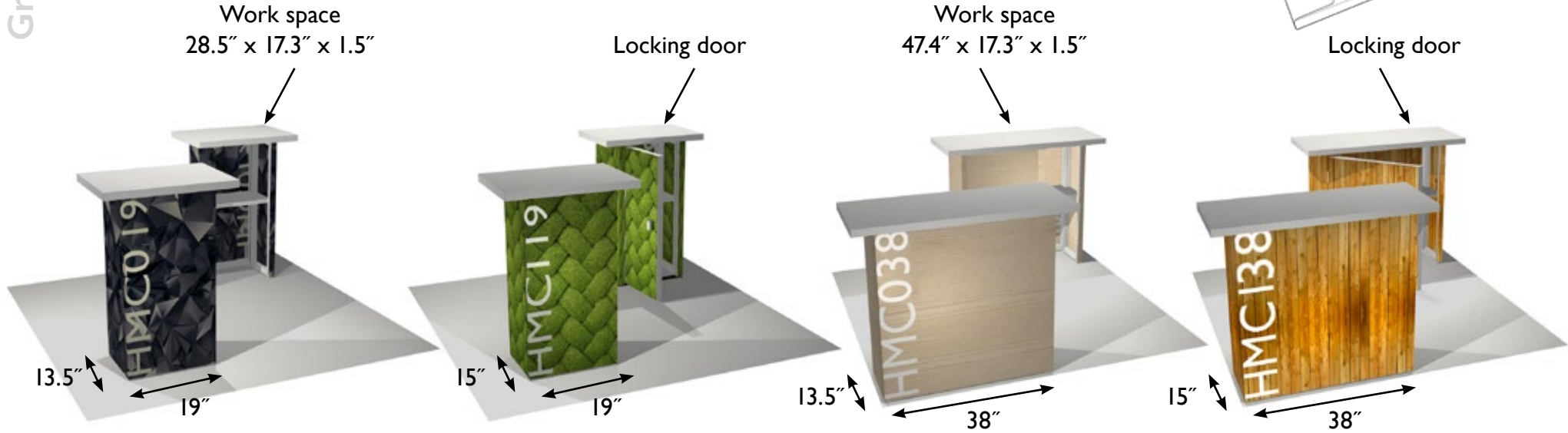

MODULES

HMC019
Small counter module
(28.5" x 17.3" x 39.5")
+ dye-sub graphics

HMC119
Small counter module with door
(28.5" x 17.3" x 39.5")
+ dye-sub graphics

HMC038
Medium counter module
(47.4" x 17.3" x 39.5")
+ dye-sub graphics

HMC138
Medium counter module
(47.4" x 17.3" x 39.5")
+ dye-sub graphics

GRAPHICS

3 dye-sub graphics

HMC019-USB 
Option with USB hub

6 dye-sub graphics

HMC119-USB 
Option with USB hub

3 dye-sub graphics

HMC038-USB 
Option with USB hub

6 dye-sub graphics

HMC138-USB 
Option with USB hub

3 | Connecting modules

Greet

Total height (countertop included) : 39.5"

Connect two HMC038
counters to create a
94.5" x 17.3" work space



Countertop and shelf
cover included

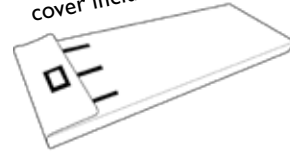

Additional work space
17.3" x 17.3"



MODULES

HMC038-L
Connecting module to connect
2 counters (straight) + dye-sub graphic

HMC004
Connecting module to connect 2
counters (angle) + dye-sub graphics

GRAPHICS

1 dye-sub graphic

3 dye-sub graphics

Lightbox counter modules

Total height (countertop included) : 39.5"

Work space
47.4" x 17.3" x 1.5"

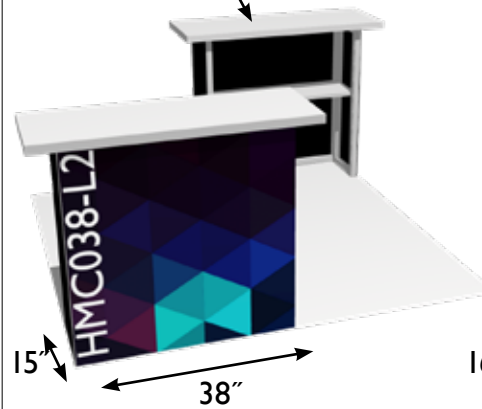

Countertop and shelf
cover included

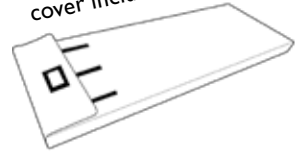

Locking door

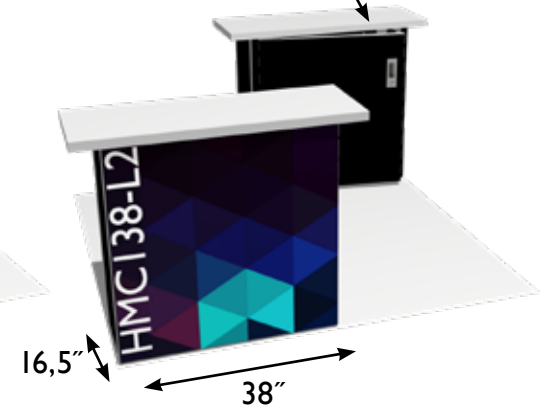

HMC038-L2
M Counter module with front
lightbox + dye-sub graphics

HMC138-L2
M counter module with door
and front lightbox + dye-sub graphics

3 dye-sub graphics

6 dye-sub graphics

HMC038-L2-USB 
Option with USB hub

HMC138-L2-USB 
Option with USB hub

*The HMC004 module is not compatible with the lightbox counters.

Lightbox ships with standard connectors.
Power supply bracket not included.

32 Console modules

Console height (incl. countertop): 39.5"

Negotiate

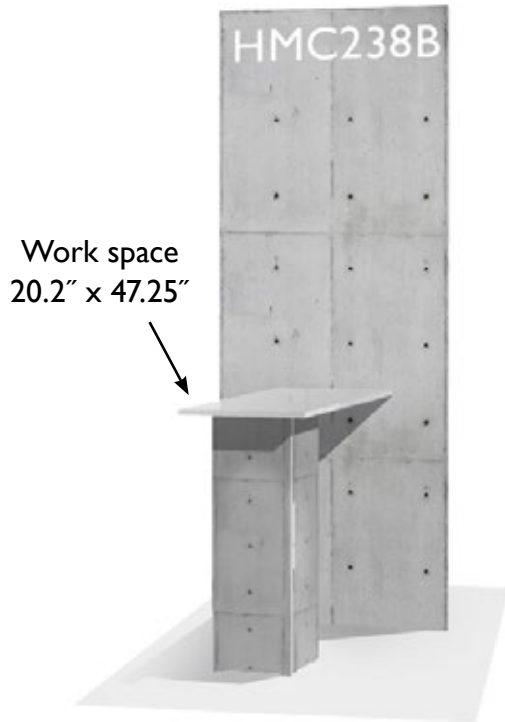

HMC238B
Console module
+ dye-sub graphics

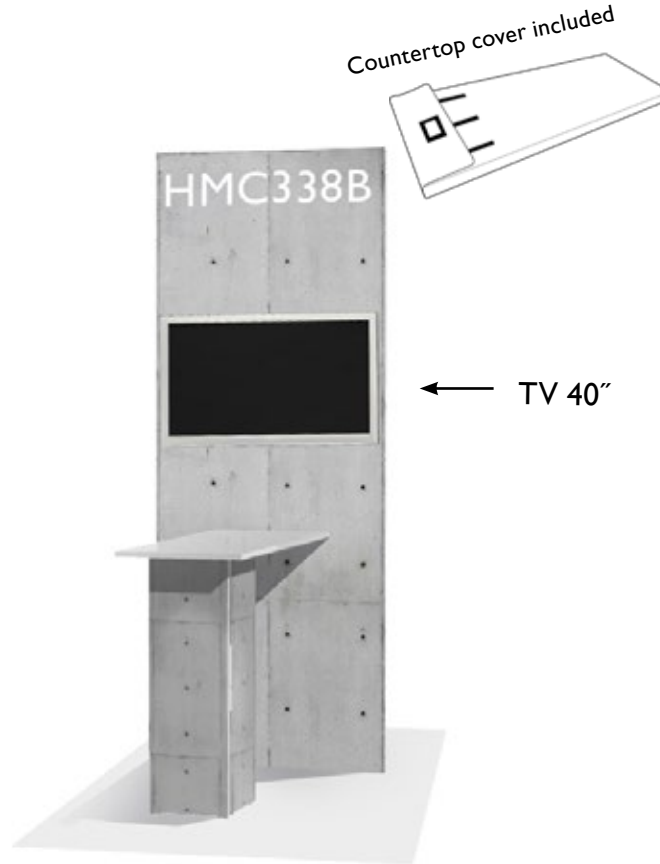

HMC338B
Console module with 40" TV*
+ dye-sub graphics

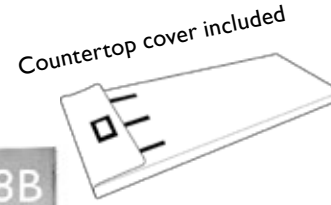

Countertop cover included



MODULES

GRAPHICS

4 dye-sub graphics

HMC238B-USB 
Option with USB hub

4 dye-sub graphics

HMC338B-USB 
Option with USB hub



Grommet for cable management

*VESA monitor mount (200 x 200 / 400 x 400) with anti-theft security included in price.
Recommended TV screen size: 40". Weight: 33 lb max. Depth: 3.9" max. Optional TV.



- Modular exhibits, ideal for 10'x10', 10'x20', 10'x30' and 20'x20' spaces
- Packaged in a wheeled crate, with frames and graphics preassembled
- May be set up with or without professional assistance



modular

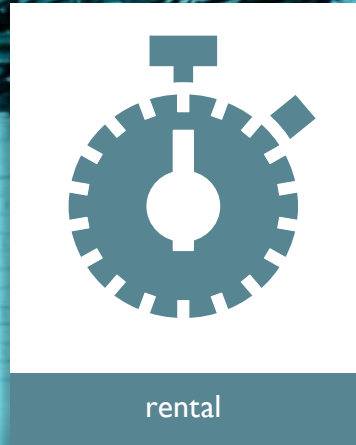

rental

modular exhibits

34 100% modular: 13 modules, 4 shows, 4 configurations, 4 locations

Reconfigure your h-line exhibit to suit your event, using the same pack of modules each time

10'x10'

Montréal



10'x10'

Chicago



10'x20'

Toronto



10'x20'

Las Vegas



35 100% modular: 13 modules for an unlimited number of configurations!

13 module pack

- 1 HMS038 standard module
- 1 HMS038-L2 standard lightbox module
- 2 HMS019 standard modules
- 2 HMSI38 standard half-height modules
- 1 HMF038-01 brochure-holder module
- 1 HMC238B console module
- 1 HMT011 shelving module
- 1 HMC119 counter module
- 1 HMR138 storage module
- 1 HMM047-L lightbox signage module
- 1 HMM138B arch module 38" + 40" TV
- 1 SOS kit
- 2 Signature LED 20W spotlight
- 1 H3 crate





h10-03

Contact us to request a quote for a purchase or renta

Suggested transport solution
1 h-line H3 crate

10'x10'

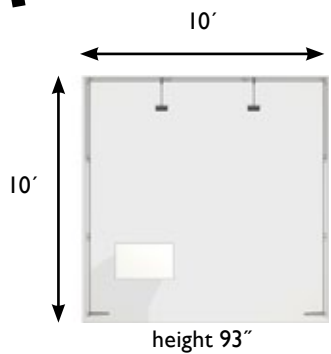

HMC119 counter



LED light



Simply add 3 more standard 38" modules to turn it into a 10'x20' exhibit



h10-06

Contact us to request a quote for a purchase or renta

Suggested transport solution
1 h-line H3 crate

10'x10'

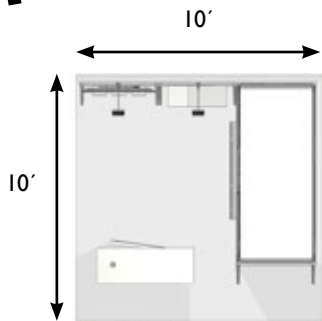

height 93"



HMC038 counter with USB hub



Add new modules and accessories to create a customized 10'x20' exhibit



h10-08

Contact us to request a quote for a purchase or renta

Suggested transport solution
1 h-line H3 crate

10'x10'

10'

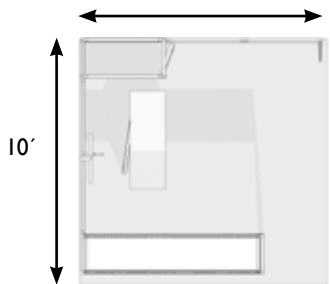

height 93"



Create a backlit arch in width of 19'



Add 2 standard modules and a TV module to turn into a 10'x20' exhibit



h10-01

Contact us to request a quote for a purchase or renta

Suggested transport solution
 3 flightcases for LED panels
 + 1 48" x 96" palet

10'x10'

10'

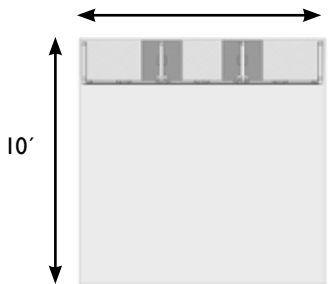

height 93"

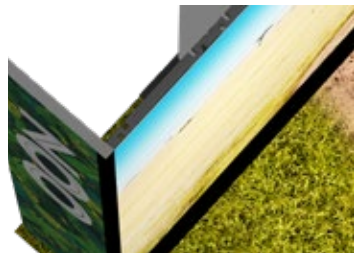

The thinnest panel: 1.57" (40 mm)

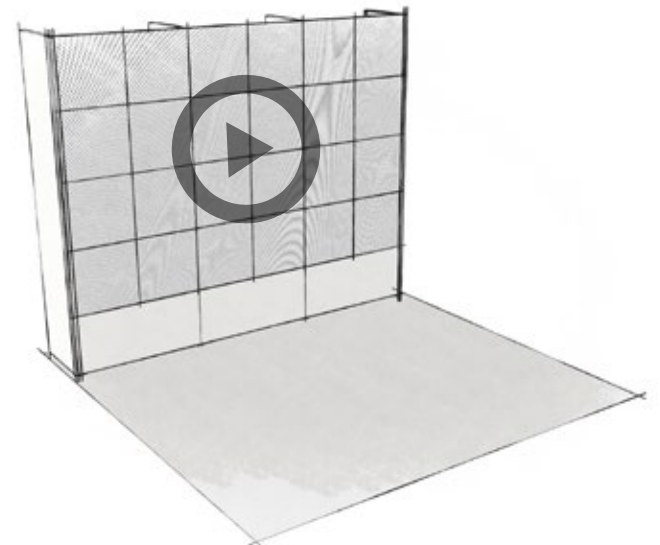

Broadcast your message on panoLED video walls

h10-02

Contact us to request a quote for a purchase or renta

Suggested transport solution
2 flightcases for LED panels
+ 1 h-line H3 crate



10'x10'

10'

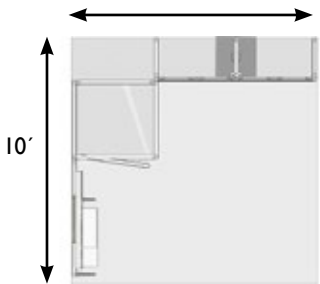

height 93"



Use compatible frames to align your video wall height to the exhibit height

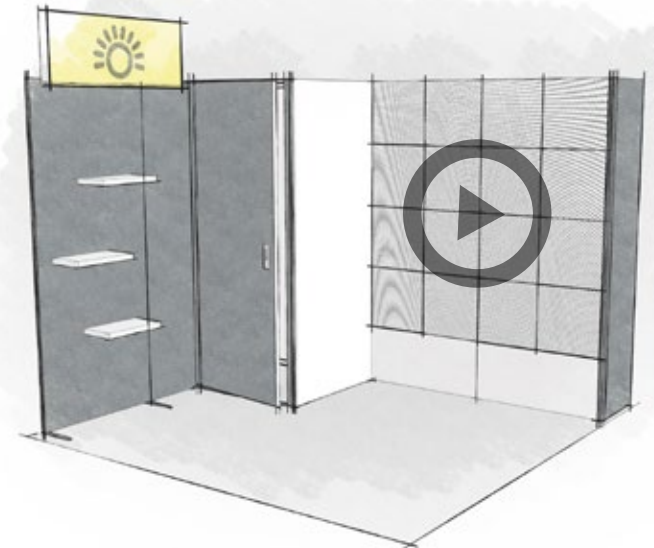

Display your items on shelves



h10-07

Contact us to request a quote for a purchase or renta

Suggested transport solution
1 h-line H3 crate

10'x10'

10'

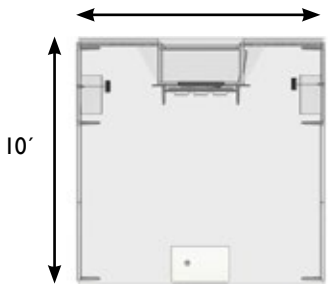

height 93"



3 brochure holders module + TV (HMM638)

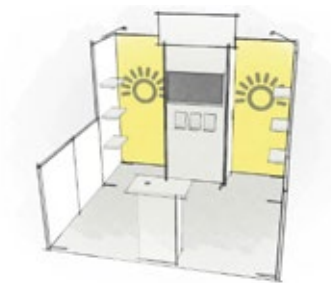

Add 2 38" lightbox modules and 2 standard 19" modules to create a 10'x20' exhibit

Combine different heights to increase impact



h20-27

Contact us to request a quote for a purchase or renta

Suggested transport solution
1 h-line H3 crate

10'x15'

15'

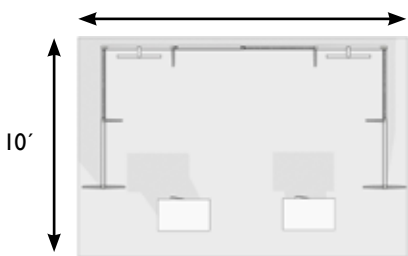

hauteur 95"



Backlit and nonbacklit modules

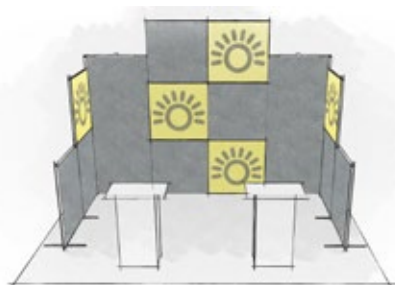

Add 2 lightbox modules and 2 standard modules to turn into a 10'x20' exhibit

Signature spotlight for powerful, homogeneous lighting



h20-12

Contact us to request a quote for a purchase or renta

Suggested transport solution
1 h-line H3 crate

10'x20'

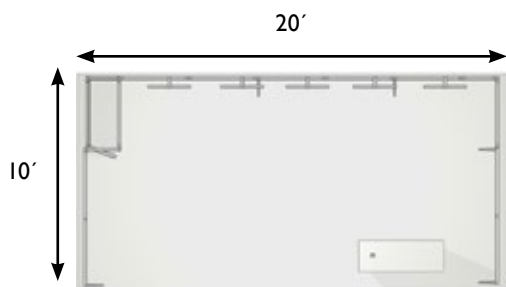

height 93"



HMC038 counter



HMR119 storage module



Remove modules and adapt to a smaller area: 10'x10'

Increase visibility with a header



h20-28

Contact us to request a quote for a purchase or renta

Suggested transport solution
I h-line H3 crate

10'x20'

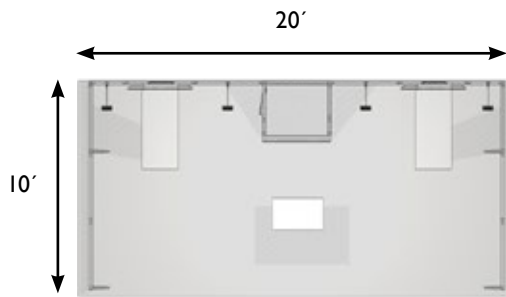

height 93"
header height: 38"



Interior shelf in each console

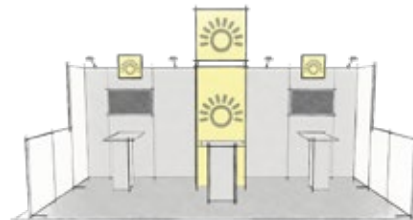

Remove modules and adapt to a smaller area: 10'x10'



Increase the impact of your communication with lightbox modules

Concentrateur USB

h2o-24

Contact us to request a quote for a purchase or renta

Suggested transport solution
2 h-line H3 crates

10'x20'

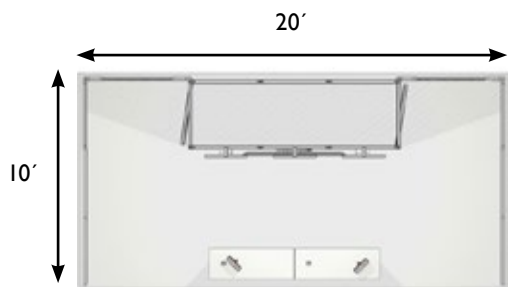

height 93"
header height: 38"



Brochure holders and TV



2 HMC038-USB counters
connected with HMC003



Add header modules to transform your exhibit into a central 20'x20' island

Vary your messages with wall.frame



h20-26

Contact us to request a quote for a purchase or renta

Suggested transport solution
I h-line H3 crate

10'x20'

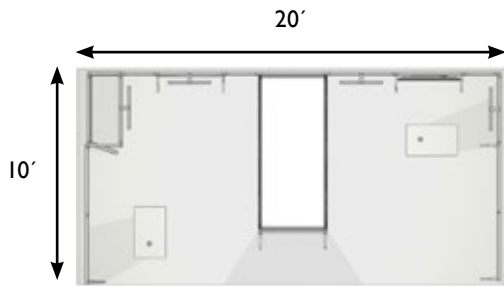

height 93"



Storage module HMR119



Increase the size of your exhibit to 10'x30':
add I storage module, I arch and I counter

h20-11

Contact us to request a quote for a purchase or renta

Suggested transport solution
2 flightcases for LED panels
+ 1 h-line H3 crate

Even more impact with the panoLED video wall



10'x20'

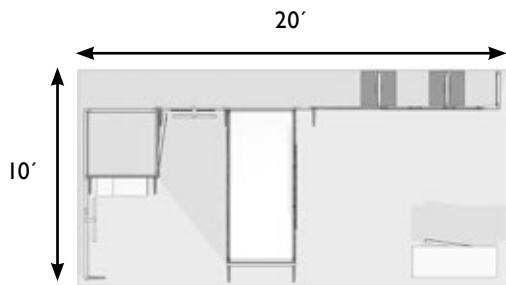

height 93"
header height: 38"



Create an optical illusion effect by combining still graphics and animated videos

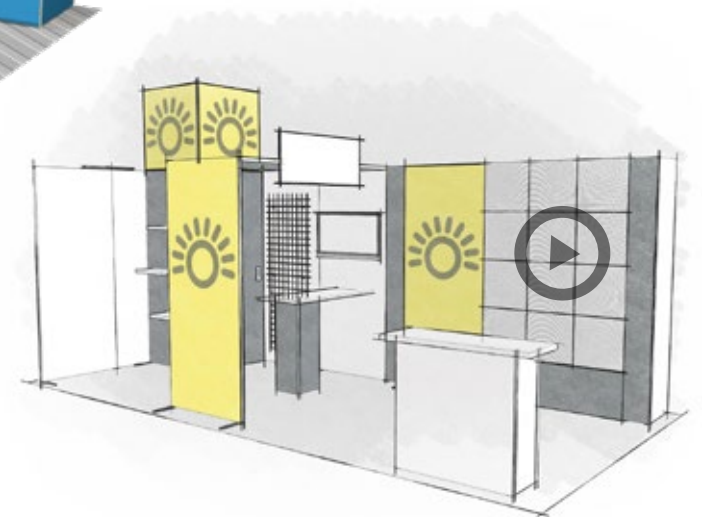



h20-29

Contact us to request a quote for a purchase or renta

Suggested transport solution
2 h-line H3 crates

Connect two counters using the connection module

20'x20'

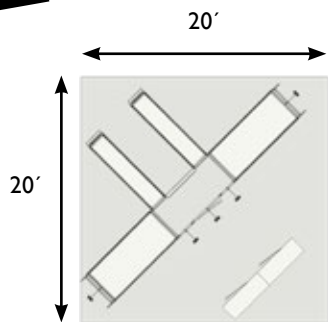

height 131"



Lightbox signs to display your logo



Add 2 standard 38" modules, 1 19" module and 1 9" module to change the layout of your exhibit to 10'x20'



Stand out with transparent module

h20-10

Contact us to request a quote for a purchase or renta

Suggested transport solution
2 h-line H3 crates

20' x 20'

20'

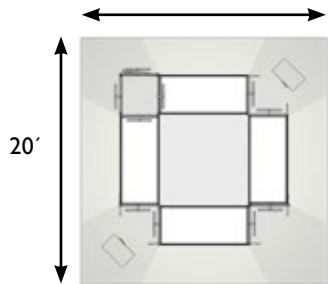

20'

height 131"



Arch module with lightbox
velum HMV438-L

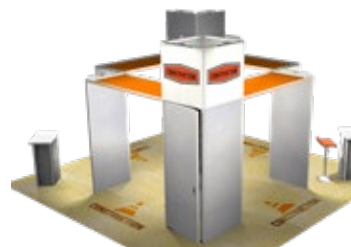

HMR038 storage module



Create a very different design
using the same area and more functionalities

Showcase your products with the helix.200 display case



h30-02

Contact us to request a quote for a purchase or renta

Suggested transport solution
2 h-line H3 crates

20'x30'

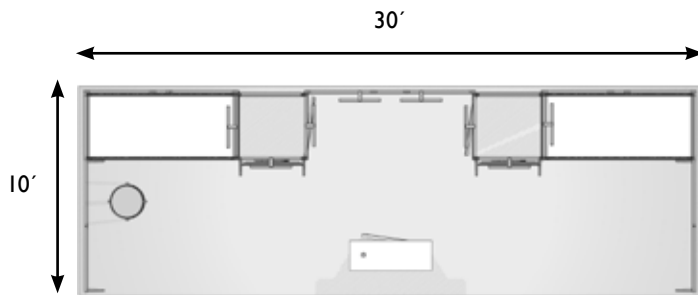
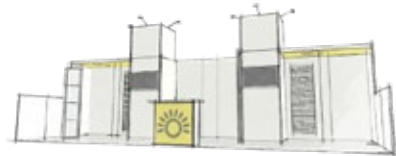

height 93"
header height: 38"



Grid module to attach various accessories



Remove modules and adapt your exhibit to a smaller area: 10'x20'

5 | Pre-fit your modules!

Accessory module
compatible

Accessoirize

TV40L (-LOC)
TV Samsung LED 3D 40"
+ remote control



ACS011-01
TV mount



ACS012-01
Tablette holder



panoLED
LED panel



ACT028-12
18.9" x 10.25" S shelf
+ 2 supports + cover



ACT028-13
20.4" x 10.25" M shelf
+ 2 supports + cover



ACT028-11
37.8" x 10.25" L shelf
+ 2 supports + cover



HCW001
wall.frame 34"x19"



COF071-01
Brochure holder



52 Pre-fit your modules!

Accessoirize

COL037
h-line connector



COL032-01
Lightbox connector



COF065-01
Power supply bracket for lightbox



HAL002
Electricity kit (two 10' extension cords + one 3-outlet power strip)



HAL004
Electricity kit with attachment piece (two 3m extension cords + one 3-outlet power strip + attachment piece for power supply)



LED4-US-S3
LED light with bag



LLF020
Transformer
+ 6 extension cords



53 Pre-fit your modules!

Accessoirize



LED-SIGNATURE-US
Signature LED 20W spotlight with
transformer and bag

With its sleek, contemporary lines, it integrates flawlessly into your booth designs.

It lights the panel powerfully and uniformly thanks to its elongated 23.62" form, as well as its specially designed optics.

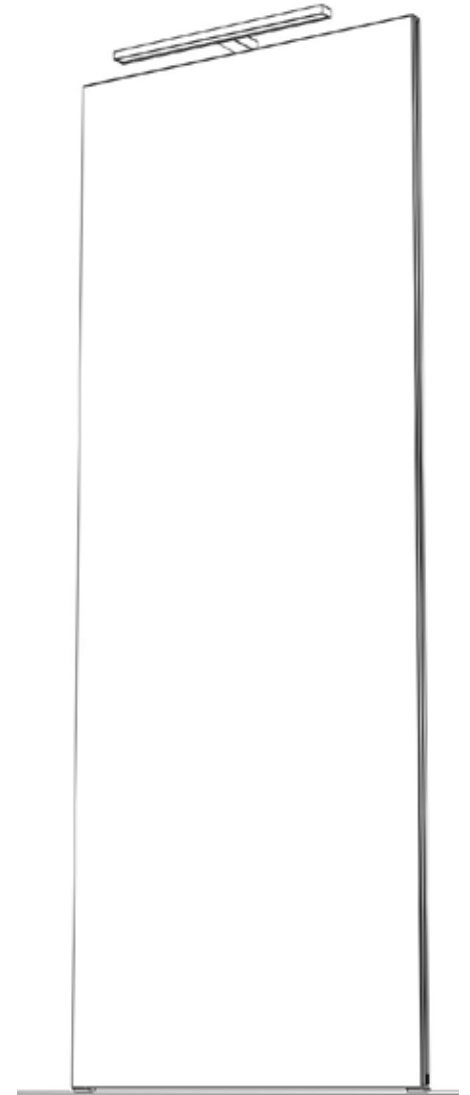

54 Pre-fit your modules!

Accessoirize

ACP022
Stabilizing foot



ACP023
Double-sided stabilizing foot



ALP005-04
Aluminum profile cover (height 93")



ALP005-07
Aluminum profile cover (height 46.5")



LLS012
Cord protector



HAR001
Storage kit for 38" storage modules (free-standing shelves, coat rack + 4 hangers and 2 trash bins)



HAR002
Closet kit for 19" closet modules (rod and 4 hangers + 1 trash bin)

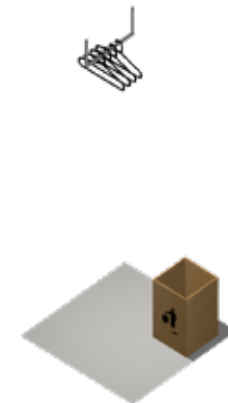

55 Travel solution

Storage crate



Track system

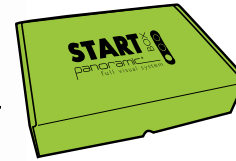









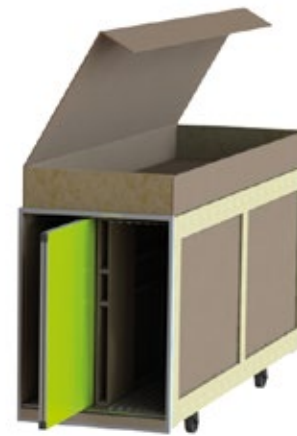









H3 Crate

External dimensions:
L 34" x P 97" x H 60"

Weight:
400 lbs

Can contain (14) 38" frames, (1) 19" frame and (1) 9.5" frame.
For use with liftgate or ramp. Includes a top case.



CONNECTOR			
ACCESSORIES	 Connection tube	 Profile cover	
	 Universal accessory attachment piece	 Counter platform	 Counter shelf
	 Stepladder	 Console platform	 Shelf
	 LED display light	 TV	 iPad
	 Extension cord	 Power strip	
STORAGE FURNISHINGS	 Hanging rod	 Shelf	 Trash bin

56 Travel solution

Storage crate



H5 Crate

External dimensions:
30.25" x 56.25"H x 96.5"

Weight:
245 lbs

Can contain 12 frames. For use without liftgate or ramp (case to be loaded wheels up in your vehicle to ensure perfect stability during transport) Includes a top case.



Partitionable crate

Even more exhibits at: panoramic-design.com

Find your exhibit in just a few clicks



panoramic™ full visual system

panoramic design search

SEARCH (28 products)

Remove filters

Categories

- 10'x10' (5)
- 10'x20' (18)
- 10'x30' (3)
- 20'x20' (2)
- counters (0)
- modules (0)
- > 20'x20' (0)

Booth Layout

- Corner (2)
- Counter (0)
- Inline (13)
- Island (11)
- Kiosk (2)
- Peninsula (0)

Price

5019 - \$ 18382

Reset this group

- Storage (24)
- Tower / Header / High signage (0)
- Shelves / Column (12)
- Semi private conf. area (16)
- Counter (4)
- Reception / Ask for

There are 28 products.

Sort by Product Name: A to Z

Product ID	Length	Width	Booth size	Price	Action
101	20'	10'	10'x20'	\$13,410.00	See the product
102	20'	10'	10'x20'	\$6,887.00	See the product
103	20'	20'	20'x20'	\$17,968.00	See the product
104	10'	10'	10'x10'	\$10,495.00	See the product
106	20'	10'			
107	10'	10'			
108	20'	20'			
109	20'	10'			

